

## Hand Operated Curtain Track System

# Silent Gliss® 1280

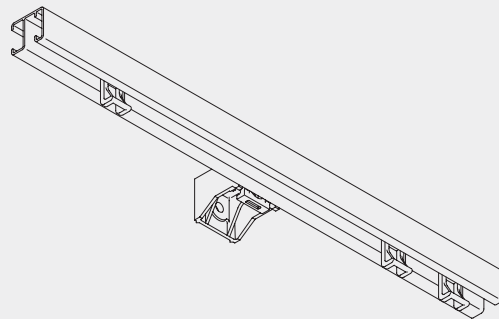

### Product Information

- Versatile hand operated curtain track system for contract and domestic applications.
- For medium to heavy weight curtains.
- Patented roller gliders glide on rim of front channel with very little friction for smooth and easy operation.
- Standard profile colour: white.
- Easy wall or ceiling fixing.
- Available in 4m, 5m and 6m lengths.
- Can be bent.



1280

## Profile, Bending and Specification Information

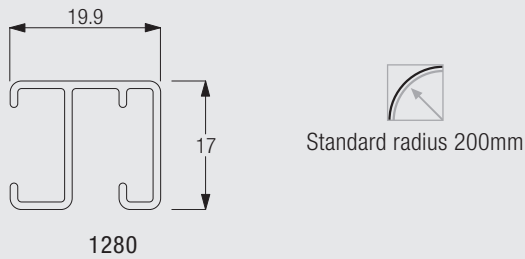

The standard radius is recommended for optimal operation. The minimum possible radius is 150mm.

**Specification Guide-** download from [www.silentgliss.co.uk](http://www.silentgliss.co.uk) (password required).

Silent Gliss 1280 hand drawn curtain track in white powder-coated aluminium. Fix to wall with brackets 3630/3660, ceiling with brackets 3603 every 300mm. Fit endcovers 3985.

## Fitting Information

### Bracket positioning and fixing with universal brackets 3603, 3630, 3655, 3660

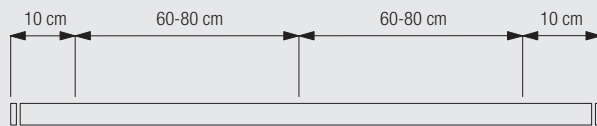

The fixing distances are meant as a guide only: they may vary in practice depending on the surface and curtain weight.

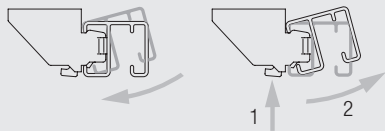

Installation: Roll track onto bracket in direction indicated  
Removal: 1. Press to release 2. Rotate forward for removal



### Quick-clip glider 3933

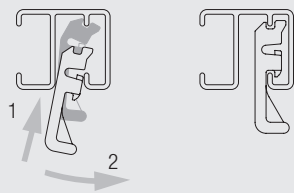

System 1280 is supplied with 3922 roller glider as standard, quick-clip glider 3933 is available as an optional accessory.

## Fitting Options

### Ceiling fix with bracket 3603

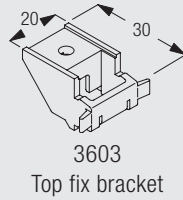
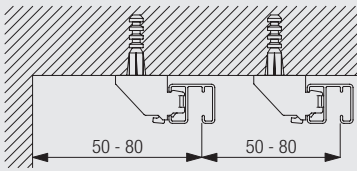

The final distances may be outside of the recommendations above depending on curtain heading, make-up and any obstructions.

### Wall fix with universal brackets 3630/3655/3660

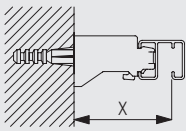

	X (mm)
3630	42
3655	57
3660	72

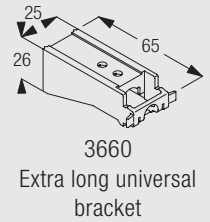
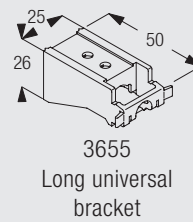
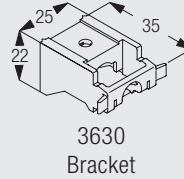

### Wall fix with brackets 3134-39 and bracket 3603

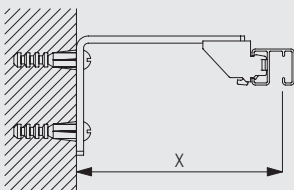

	X (mm)	W (mm)	Y (mm)	Z (mm)
3134	84	-	50	-
3135	104	-	50	50
3136	124	-	50	50
3137	144	-	80	50
3138	174	60	80	60
3139	224	85	80	85

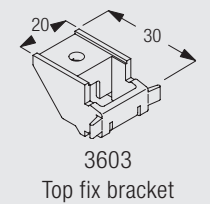
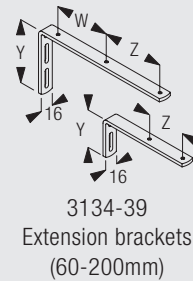

Brackets are threaded for screw 6748 (M4 x 8).

### Wall fix with extension brackets 3275-77

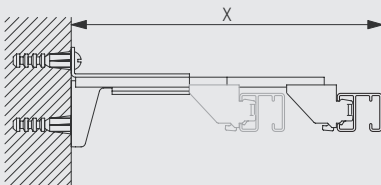

	X (mm)
3275	81-110
3276	104-134
3277	134-164

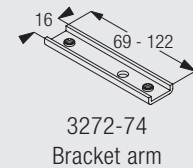
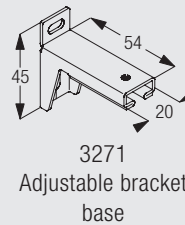

## Standard Accessories

18R Screw 25mm. No. 8 roundhead

1280 Profile

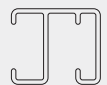

3630 Bracket

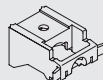











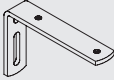
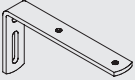

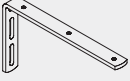
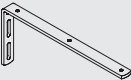

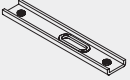



3922 Roller 3911 in strip form

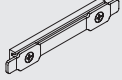
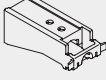

3985	Endcover	
------	----------	---

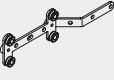
## Optional Accessories

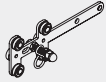
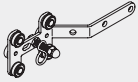
3133	Bracket cover (60mm)		3134	Extension bracket (60mm)	
3135	Extension bracket (80mm)		3136	Extension bracket (100mm)	
3137	Extension bracket (120mm)		3138	Extension bracket (150mm)	
3139	Extension bracket (200mm)		3271	Adjustable bracket base	
3272	Adjustable bracket arm (69mm)		3273	Adjustable bracket arm (92mm)	
3274	Adjustable bracket arm (122mm)		3275	Adjustable extension bracket set (69mm)	
3276	Adjustable extension bracket set (92mm)		3277	Adjustable extension bracket set (122mm)	
3603	Top fix bracket		3620	Connecting bridge	
3660	Extra long universal bracket		3932	Spring stop	
3933	Glider 3933 in strip form		3942	Endstop	
3975	Overlap arm for pulling by hand		4092	Plastic draw rod (4092S Aluminium)	
6748	Cheese head machine screw (M4)		3133L	Extended bracket cover for 3138/9	
3935A 3949	Overlap arm straight with S-hook		3936A	Overlap arm with s-hook 3949	

1280

## Useful Information and Sewing Accessories

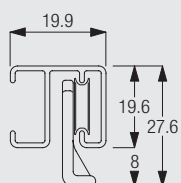
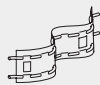

Diagram uses standard 3922 glider and is measured to the inside of the glider eye. For optional gliders substitute dimensions below:  
 3945/3946 = 8mm  
 3933 = 8mm

3562 Standard tape



3582 Hook



3599 Hook



## Useful Measurements

3620 Connecting bridge

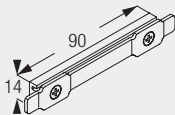

1280