

## Hand Operated Curtain Track System

# Silent Gliss<sup>®</sup> 6243

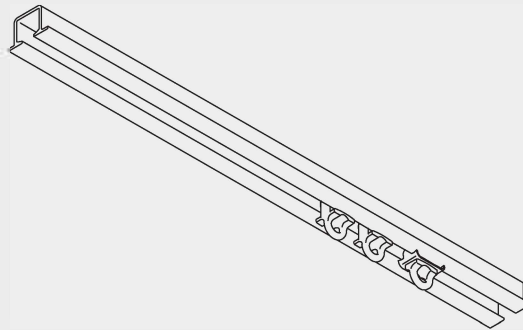

### Product Information

- Single channel curtain track for medium to heavy weight contract applications.
- Thin and bendable recess profile with 5.4mm gliding channel.
- Minimum bending radius 20cm.
- Punched every 200mm.
- Supplied in white as standard.
- Standard profile length is 6m (connecting bridge available for longer lengths).
- Can be bent.
- Available with Wave and Wave XL curtain heading systems.



6243

## Profile and Bending Information

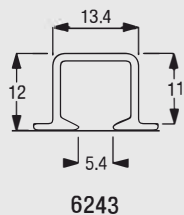

Min. radius 20cm

6243

### Specification Guide

Silent Gliss 6243 curtain track, hand-drawn, anodised aluminium, complete with gliders 6096 at 16/m. 1 end stop 6065 and 1 spring stop 6053 per length. Top fixed with pre-drilled holes every 400mm.

## Fitting Information

### Fixing points



The fixing distances are meant as a guide only; they may vary in practice depending on surface and curtain weight.

### Stack Depth Wave Standard

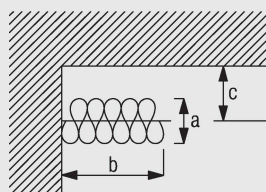

6243

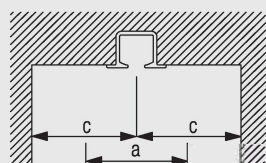

a = Stack depth  
b = Stack size  
c = Min. distance

Glider-cord spacing	Curtain hook spacing	Approx. curtain fullness	Stack depth (a)	Stack width (b)	Min distance (c)
6	10	1.9	10	23 per metre of track + endpiece	8
6	12	2.2	12	23 per metre of track + endpiece	9
8	14	2.0	14	18 per metre of track + endpiece	10
8	16	2.2	16	18 per metre of track + endpiece	11

#### Wave standard with roller gliders

Glider-cord spacing	Curtain hook spacing	Approx. curtain fullness	Stack depth (a)	Stack width (b)	Min distance (c)
8	14	2.0	14	21 per metre of track + endpiece	10
8	16	2.2	16	21 per metre of track + endpiece	11



(dimensions in cm)

Note: Minimum distance (c) includes a standard 4.5cm clearance (front and back).

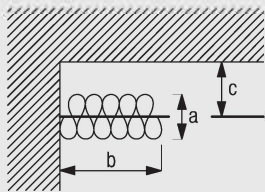
## Stack size calculation Wave XL

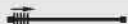

a = Stack depth 35cm  
b = Stack size  
c = Min. distance 22cm

System width		77-107	108-143	144-179	180-215	216-251	252-287	288-323	324-359	360-395
	b	28	33	38	43	48	53	58	63	68
System width		396-431	432-468	469-503	504-539	540-575	576-600			
	b	73	78	83	88	93	98			
System width		154-217	218-289	290-361	362-433	434-505	506-577	578-600		
	b	28	33	38	43	48	53	58		

(dimensions in cm)

## System Options

### Wave Standard curtain heading system

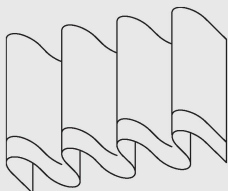

Wave is an exciting new contemporary curtain heading system which allows curtains to hang in a continuous wave which is smooth, simple and elegant.

When using the Wave curtain heading system please note that the maximum recommended curtain weight is 2.5kg/m or 10kg/m with wave roller glider 6098W.

The Wave Standard components are:

6345 Glider-cord 60mm  
6346 Glider-cord 80mm  
6007 End stop

The items listed below are all supplied at an additional cost as per the price list:

Wave hardware components for Enhanced Wave are:

2255 Adjustable brake  
6364 Extension (used with 6365)  
6365 Hanger (used with 6364)  
6366 Carrier for draw rod

Roller gliders 6098W must be ordered separately:

Optional enhanced components to improve the presentation of the curtain:

3582 Hook  
6349 Wave curtain tape  
6363 Iron on top hemming tape  
10075 Lead weight for hem of curtain 50 gr/m  
10076 Fabric weight for side edge of curtain

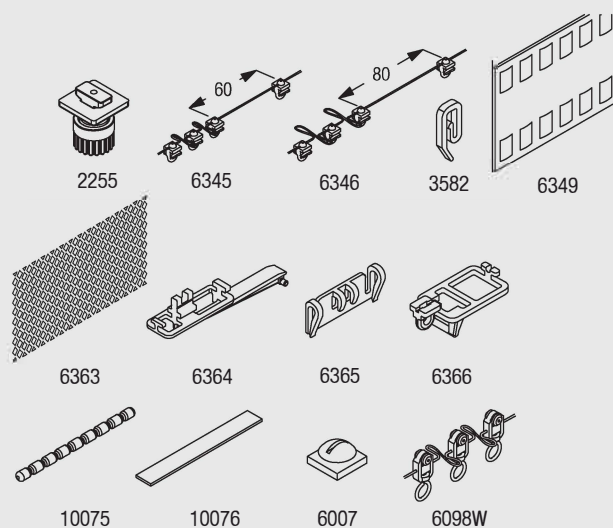

### Wave XL curtain heading system

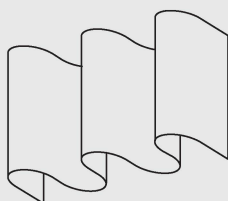

Wave XL is especially designed for high and large application areas through generously designed waves with large cross section dimensions.



6243

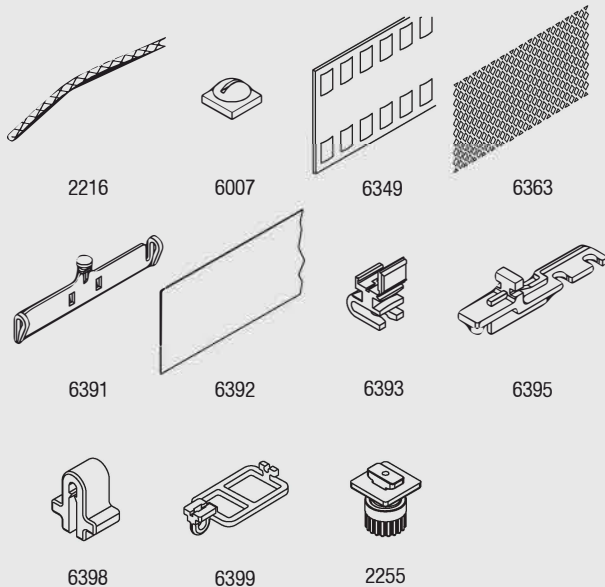

The Wave XL components are:

- 2216 Cord 0.85 mm
- 2255 Adjustable brake
- 6007 End stop
- 6349 Curtain tape
- 6363 Iron tape
- 6382 Limit stop
- 6391 Hanger
- 6392 Heading film
- 6393 Glider
- 6394 Carrier
- 6395 Extension
- 6398 Clip
- 6399 Carrier for draw rod

## Fitting Options

CAD download through Silent Gliss e-catalogue

### Recess ceiling fix

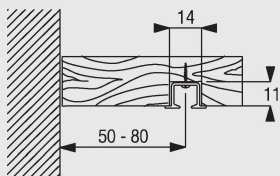

The final distances from the wall depend on curtain weight, make-up and any obstructions. The profile is pre-drilled every 400mm.



6243

## Standard Accessories

3025 Special screw (18mm)



6053 Spring stop



6065 Twist eye endstop



6096 Glider 6083 in strip form



6243 Profile



7002 Profile protector



## Optional Accessories

2255 Adjustable brake



3067 Connecting bridge



3582 Hook



6057 Hook



6083 Glider



6086 Spring stop



6096 Glider 6083 in strip form



6346 Wave glider cord (80mm)



6363 Top hemming tape



6365 Hanger



6391 Hanger



6393 Glider



6398 Clip



10075 Lead weight 50 gr/m



6098W Wave roller glider cord (80mm)



6345 Wave glider cord (60mm)



6349 Curtain tape



6364 Extension

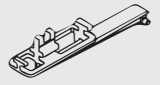

6366 Carrier for draw rod

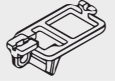

6392 Heading film



6395 Extension



6399 Carrier for Draw rod

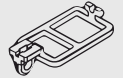

10076 Fabric weight



6243