

SG 6243

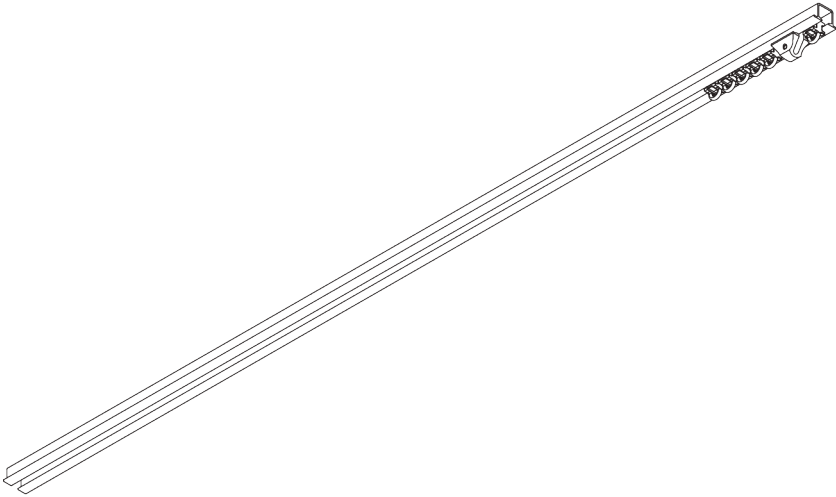

PRODUCT INFORMATION

- **Operation:** hand
- **Range:** S - M
- **Fitting:** recess
- **Colours:** white RAL 9016; special colours or anodised aluminum possible
- **Fabrics:** refer to Silent Gliss fabric collection

Features:

- 2-component (2C) glider technology
- Wave (2C)
- Bendable
- Pre-drilled profile

SYSTEM SPECIFICATIONS

A. PROFILE

Profile and bending information

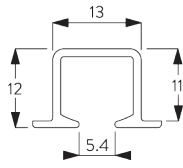

SG 6243p

Profile

Radius:
✓ 20 cm, >25 cm

B. HOW TO MEASURE

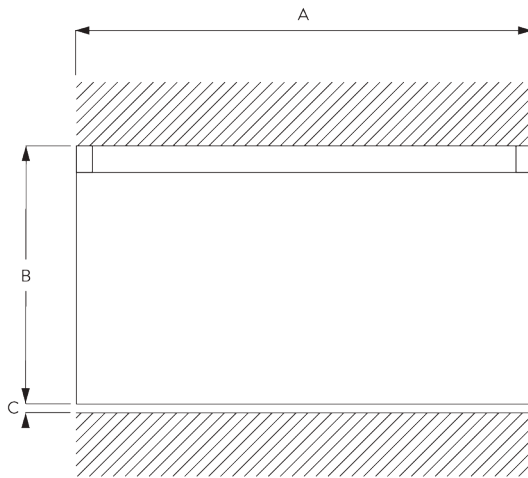

A: System width

B: System height

C: Distance between floor and fabric

C. SPECIFICATION

TEXT

Silent Gliss SG 6243 Hand Operated Curtain Track System. Comprises aluminium profile SG 6243 supplied made to measure powder coated white with gliders SG 11300 at 14/m, 1 end stop SG 6065 and 1 spring stop SG 6053 per length. Top fixed with screw SG 0240 into timber through pre drilled holes every 400mm.

FITTING

A. FITTING INFORMATION

Fixing points

For detailed fitting information, visit the [Silent Gliss website](#).

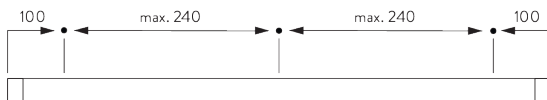

B. RECESS FITTING

Direct into wood

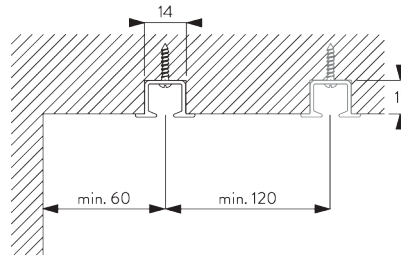

Recess channel: 11 x 14 mm

SYSTEM OPTIONS

A. WAVE

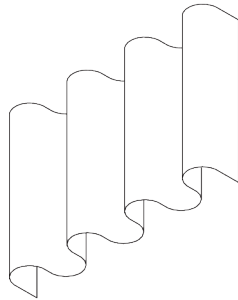

SG 11295

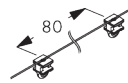

SG 11302

Standard components:

- SG 11295 End stop
- SG 11302 Wave 2C glider cord 80 mm



SG 2255

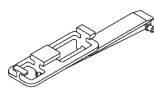

SG 6364



SG 6365

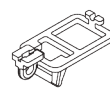

SG 6366

Optional components (min. radius >25 cm):

- SG 2255 Brake
- SG 6364 Wave extension
- SG 6365 Wave hanger
- SG 6366 Wave carrier for draw rod
- SG 10430-34 Draw rod
- SG 11303 Wave 2C glider cord 60 mm

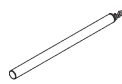

SG 10430-34

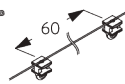

SG 11303

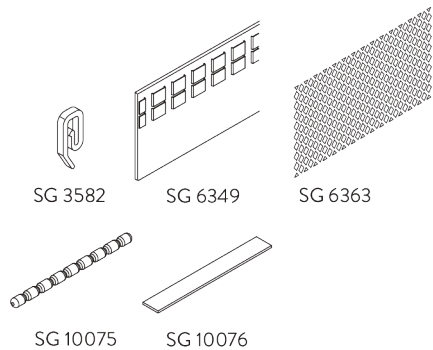

Curtain components:

- SG 3582 Hook
- SG 6349 Wave curtain tape
- SG 6363 Wave top hemming tape
- SG 10075 Lead weight 50 gr/m
- SG 10076 Fabric weight

Wave stack depth - 2C glider cord (standard components)

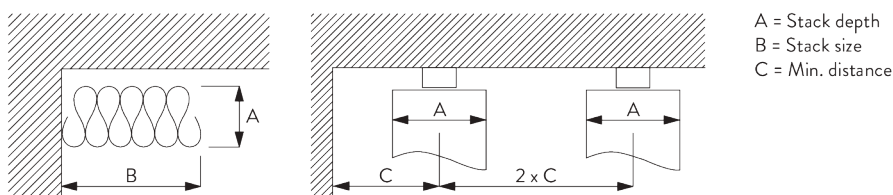

2C Glider cord SG 11302	Pockets between hooks	Approx. curtain fullness	Stack depth A	Stack size B*	Min distance C
80	6	~2.1	140	180 per metre of track	90
80	7	~2.3	160	180 per metre of track	100

2C Glider cord SG 11303	Pockets between hooks	Approx. curtain fullness	Stack depth A	Stack size B*	Min distance C
60	4	~2.1	100	230 per metre of track	70
60	5	~2.3	120	230 per metre of track	80

**Stack size B when using optional extension arm SG 6364 increases by 95 mm per curtain!*

GENERAL NOTES

Dimensions

- Measurements are in mm except where indicated.
- Max. kg relates to fabric incl. accessories.
- Stack size depends on curtain make-up and fabric thickness.
- Distance between gliders max. 80 mm / distance between rollers max. 100 mm.
- Recommended distance floor / fabric: 20 mm.
- In order to determine system height (B), the smallest room height must be taken into account.

Fitting





- Installation by qualified fitter only.
- Number of brackets and fitting positions / fixing points vary depending on fitting surface, system weight, fabric make-up, screw / fixing type and obstacles.
- Qualified fitter must use appropriate screws / fixings for each situation.
- Profile lip if applicable to be installed to room side.

Child Safety





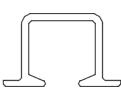
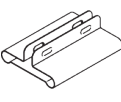

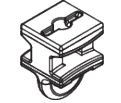



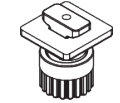
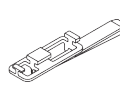

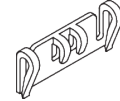
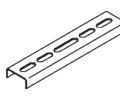
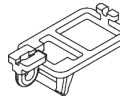
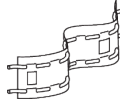

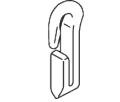
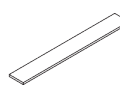
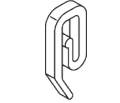
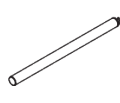
- All relevant Silent Gliss systems correspond to child safety EN 13120.
- All parties involved must comply with EN 13120.

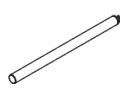
PARTS

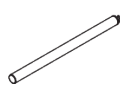
A. STANDARD PARTS

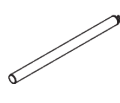
	SG 6053 Spring stop
	SG 6065 End stop
	SG 6243p Profile
	SG 7002 Profile protector
	SG 10717 Countersunk head screw 2.2x19
	SG 11300 2C glider

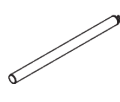
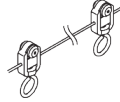
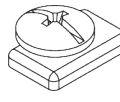
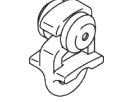
B. OPTIONAL PARTS

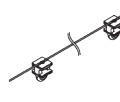
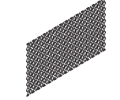
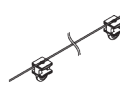
	SG 2255 Brake		SG 6364 Wave extension
	SG 3020 Hook		SG 6365 Wave hanger
	SG 3067 Connection bridge		SG 6366 Wave carrier for draw rod
	SG 3562 Heading tape		SG 10075 Lead weight 50 g/m
	SG 3571 Hook		SG 10076 Fabric weight
	SG 3582 Hook		SG 10430 Draw rod 50 cm
	SG 3599 Hook		SG 10431 Draw rod 75 cm
	SG 6064 End stop		SG 10432 Draw rod 100 cm
	SG 6094 Roller		SG 10433 Draw rod 125 cm
	SG 6098 Roller		SG 10434 Draw rod 150 cm
	SG 6099 Wave roller cord 80 mm		SG 11295 End stop
	SG 6283 Roller		SG 11301 2C glider on strip
	SG 6349 Wave curtain tape		SG 11302 Wave 2C glider cord 80 mm
	SG 6363 Wave top hemming tape		SG 11303 Wave 2C glider cord 60 mm

