

# SG 4730

---

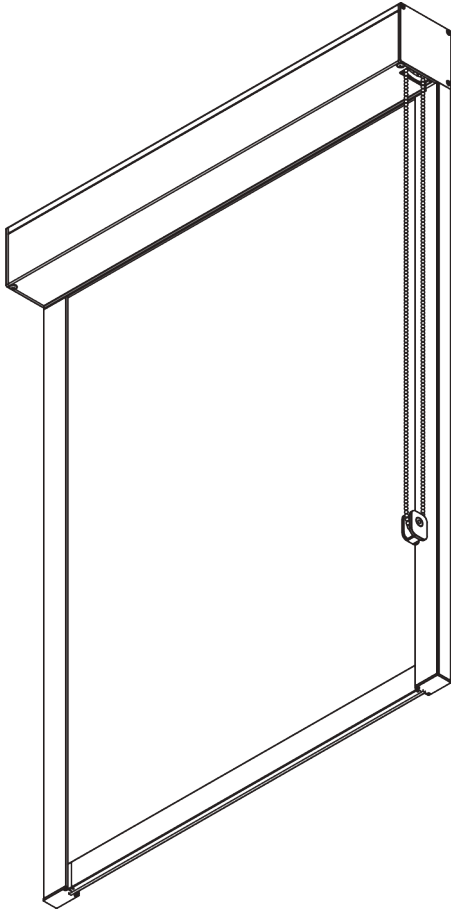
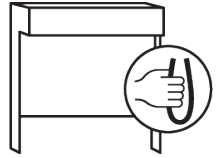

## PRODUCT INFORMATION

- **Operation:** chain
- **Range:** M
- **Fitting:** ceiling, wall, recess
- **Colours:** white RAL 9016 or black RAL 9005, special colours possible
- **Fabrics:** refer to Silent Gliss fabric collection

### **Features:**

- Zip technology
- Stainless steel bead chain
- 2-to-1 gear drive
- 40 mm side channel, pre-drilled fixing points

# SYSTEM SPECIFICATIONS

## A. SYSTEM DIMENSIONS



2.2 m

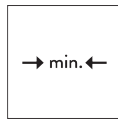

65 cm

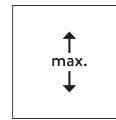

2.4 m



5.3 m<sup>2</sup>



3.7 kg

## B. PROFILE

### Profile information

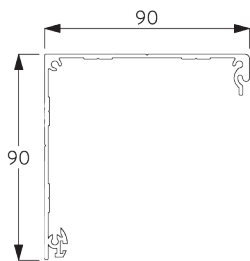

**SG 10996**

Box case 90 mm

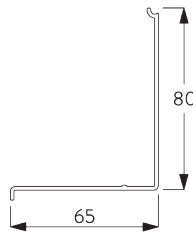

**SG 10997**

Box cover 90 mm

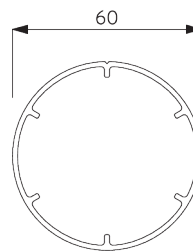

**SG 11037**

Tube ø 60 mm

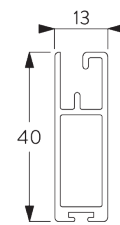

**SG 10993**

Bottom bar

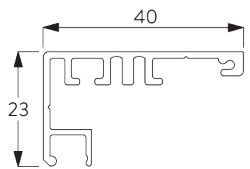

**SG 11418**

Side guide case

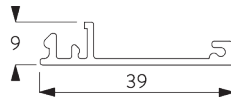

**SG 11419**

Side guide cover

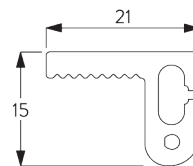

**SG 11421**

Zip profile

## C. HOW TO MEASURE

### Inside fitting

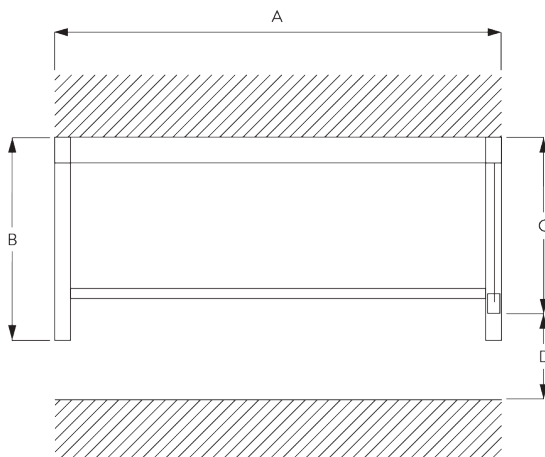

A: System width

B: System height

C: Chain height

D: Safety Retainer SG 10731 min. 150 cm above floor

## Face fitting

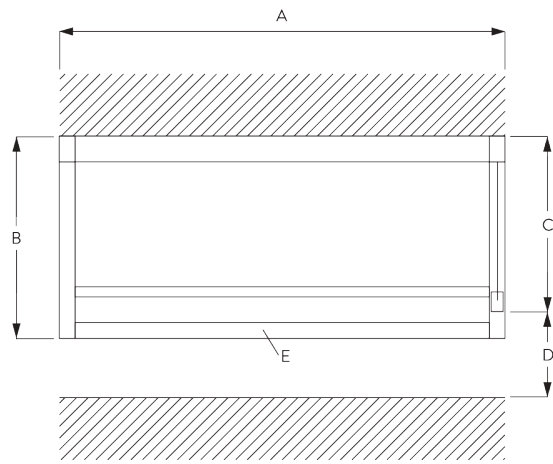

- A: System width
- B: System height
- C: Chain height
- D: Safety Retainer SG 10731 min. 150 cm above floor
- E: Optional: end profile (SG 11418 / SG 11419)

## D. SPECIFICATION TEXT

**Silent Gliss SG 4730 Chain Operated Dim-Out Roller Blind System.** For blinds up to 2.2m wide by 2.4m drop, max 5.3 sq. m. Supplied complete and made to measure comprising aluminium headbox SG 10996-7 (90mm), side profiles SG 11418 / SG 11419 and bottom hem bar SG 10993 in white or black powder coat finish as standard. Fabric edges retained by two component zip profile SG 11421. Operation by stainless steel bead chain with chain retainer SG 10731. Compliant to Child Safety Legislation EN 13120. Fabric to be chosen from the Silent Gliss fabric range, Price Group 1R / 2R / 3R.

# FITTING

## A. FITTING INFORMATION

For detailed fitting information, visit the Silent Gliss website.

### Inside fitting - fixing points

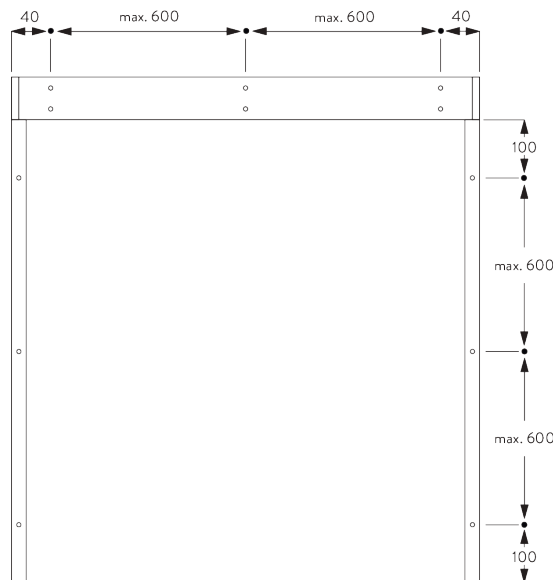

**Face fitting - fixing points**

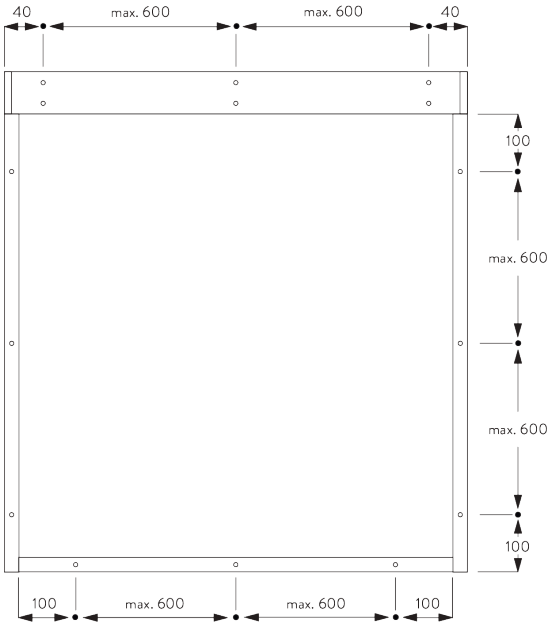

**B. CEILING FITTING**

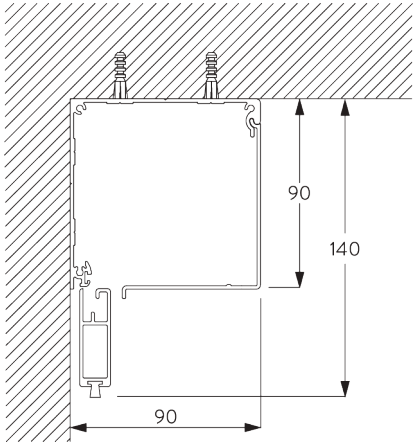

**C. WALL FITTING**

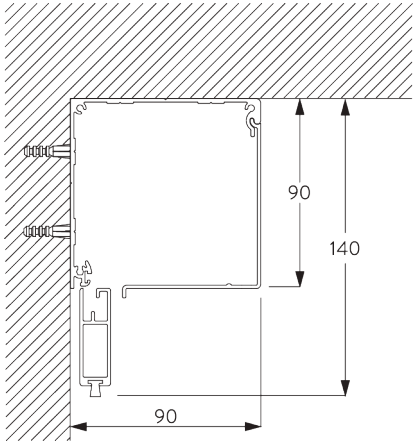

**D. RECESS FITTING**

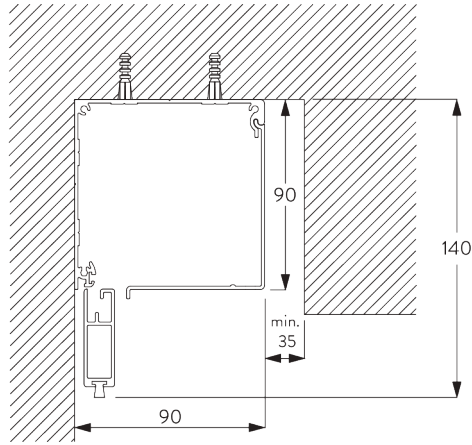

**E. SIDE PROFILES**  
**SG 11418 / SG 11419**

**Inside fitting**

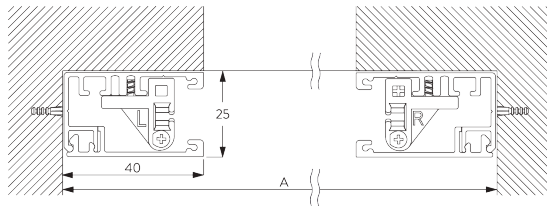

A: System width

**Face fitting**

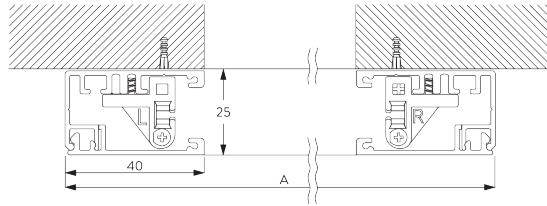

A: System width

# GENERAL NOTES

## **Dimensions**

- Measurements are in mm except where indicated.
- Max. kg relates to fabric incl. accessories (bottom bars, etc.).

## **Fitting**











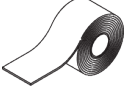

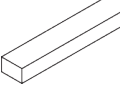
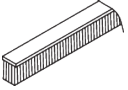

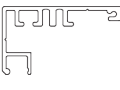
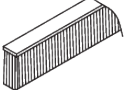

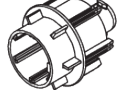
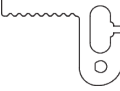
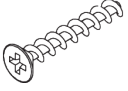
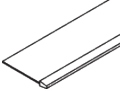
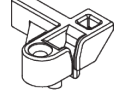
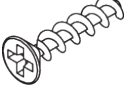
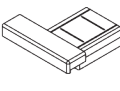
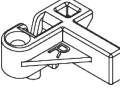

- Installation by qualified fitter only.
- Number of brackets and fitting positions / fixing points vary depending on fitting surface, system weight, fabric make-up, screw / fixing type and obstacles.
- Qualified fitter must use appropriate screws / fixings for each situation.
- Profile lip if applicable to be installed to room side.
- Electrical installations must be carried out according to Silent Gliss wiring diagrams and conform to local regulations.
- Check space for cables and plugs!

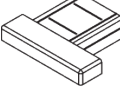
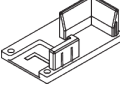
## **Child Safety**

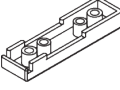
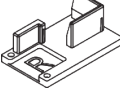
- All relevant Silent Gliss systems correspond to child safety EN 13120.
- All parties involved must comply with EN 13120.

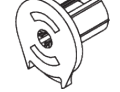
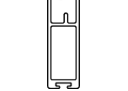
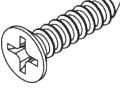
# PARTS

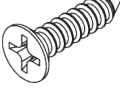
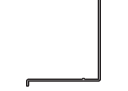
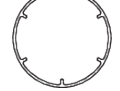
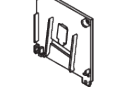
## A. STANDARD PARTS

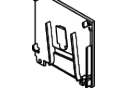
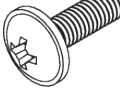
	<b>SG 4226</b> Double tape 30 mm		<b>SG 11011</b> Clip		<b>SG 11060</b> Foam tape adhesive
	<b>SG 4508</b> Brush 5x7 mm		<b>SG 11012</b> Clip		<b>SG 11418</b> Side guide case
	<b>SG 4509</b> Brush 5x12 mm		<b>SG 11017</b> Tube adapter		<b>SG 11419</b> Side guide cover
	<b>SG 6791</b> Pan head screw 3.9x32		<b>SG 11018</b> Tube adapter		<b>SG 11421</b> Zip profile
	<b>SG 6933</b> PT Countersunk screw KA25x16		<b>SG 11025</b> Zip		<b>SG 11473</b> Zip guide left
	<b>SG 6936</b> PT Countersunk screw KA22x10		<b>SG 11028</b> End cover left		<b>SG 11474</b> Zip guide right
	<b>SG 6942</b> Pan head screw KA30x8		<b>SG 11029</b> End cover right		<b>SG 11475</b> Side guide end cover left
	<b>SG 10668</b> PVC strip 10 mm		<b>SG 11030</b> Cover		<b>SG 11476</b> Side guide end cover right
	<b>SG 10731</b> Child safety retainer set		<b>SG 11032</b> Chain drive		
	<b>SG 10993</b> Bottom bar		<b>SG 11034</b> Countersunk head screw 3.5x16		
	<b>SG 10996</b> Box case 90 mm		<b>SG 11035</b> Countersunk head screw 2.2x9.5		
	<b>SG 10997</b> Box cover 90 mm		<b>SG 11037</b> Tube ø 60 mm		
	<b>SG 11006</b> End cover left 90 mm		<b>SG 11040</b> Bead chain ø 4.5 mm		
	<b>SG 11007</b> End cover right 90 mm		<b>SG 11059</b> Pan head screw with flange M4x12		

## **B. OPTIONAL PARTS**

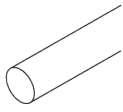

**SG 4951**

*Bottom weight ø 8 mm*



**SG 11050**

*Spring left*



**SG 11051**

*Spring right*