

Hand Operated Curtain Track System

Silent Gliss® 6010

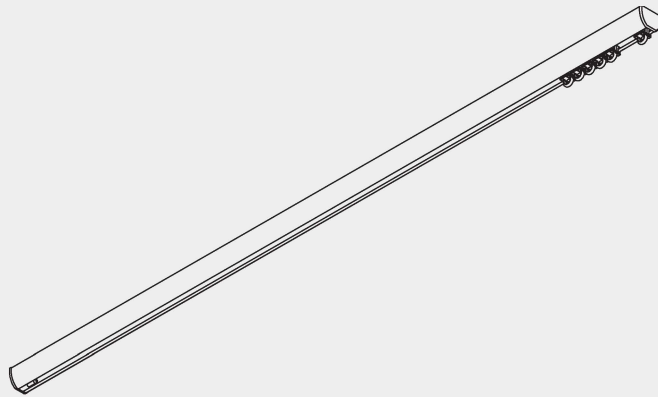

Product Information

- Operation: hand drawn
- Size range: M
- Colours: white
- Shape: oval
- 2C glider technology
- Wave compatible
- Bendable



6010

Profile and Bending Information

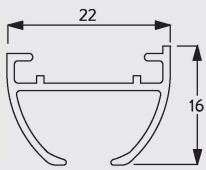

6010



Minimum radius 15cm.

Specification text:

Silent Gliss SG 6010 Hand Operated Curtain Track System. Comprises aluminium profile SG 6010 supplied made to measure powder coated in white. Supplied as standard with 2C gliders SG 11300 at 14/m, 2 end covers SG 6018 and 2 end stops SG 6065. Top fixed with clamp SG 3825 at 500mm centres. Wall fix with SG Smart Fix brackets SG 11201-11205 and SG 3832 or SG 3825 / SG Square Smart Fix brackets SG 11210-11215 and SG 3832 or SG 3825 / Universal Smart Fix brackets SG 11154-11156 and SG 3832 or SG 3825. Silent Gliss Wave option is available using 60mm glider cord SG 11303 / 80mm glider cord SG 11302.

How to measure

Stack depth Wave Standard

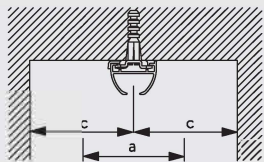
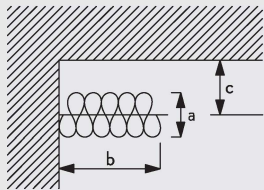

a = Stack depth
b = Stack size
c = Min. distance

Glider-cord spacing	Curtain hook spacing	Approx. curtain fullness	Stack depth (a)	Stack width (b)	Min distance (c)
6	10	2.1	10	23 per metre of track + endpiece	8
6	12	2.3	12	23 per metre of track + endpiece	9
8	14	2.1	14	18 per metre of track + endpiece	10
8	16	2.3	16	18 per metre of track + endpiece	11

Wave standard with roller gliders

Glider-cord spacing	Curtain hook spacing	Approx. curtain fullness	Stack depth (a)	Stack width (b)	Min distance (c)
8	14	2.1	14	21 per metre of track + endpiece	10
8	16	2.3	16	21 per metre of track + endpiece	11

(dimensions in cm)

Note: Minimum distance (c) includes a standard 3cm clearance (front and back).

System Options

Wave curtain heading system

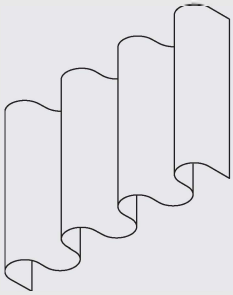

The Wave is an exciting contemporary curtain heading system which allows curtains to hang in a continuous wave which is smooth, simple and elegant.

The Wave standard components are:

- 11303 Wave 2C Glider Cord 60mm
- 11302 Wave 2C Glider Cord 80mm
- 6007 End stop
- 6315 Pilot runner

The items listed below for Enhanced Wave (80mm glider cord only) are all supplied at an additional cost as per the price list.

- 2255 Adjustable brake
- 6364 Extension (used with 6365)
- 6365 Hanger (used with 6364)
- 6366 Carrier for draw rod

Roller Gliders must be ordered separately
6099 Wave roller glider 80mm

Optional components to improve the presentation of the curtain:

- 3582 Hook
- 6349 Curtain tape
- 6363 Iron-on top hemming tape
- 10075 Lead weight for hem of curtain 50gr/m
- 10076 Fabric weight for side edge of curtain

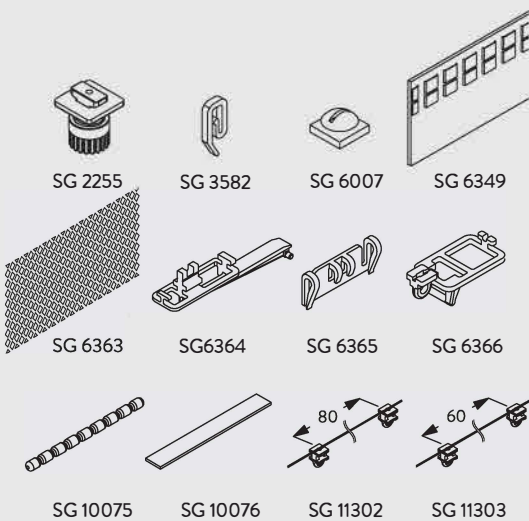

Fitting Information

Ceiling fixing with clamp 3825

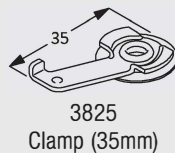
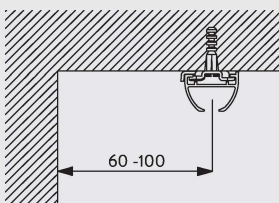

Fix track with at least one clamp 3825 every 300-600mm.
Higher edge of profile to room side. The final distances depend on system height and width and the way of confectioning.

Wall fitting with Smart Fix 11200-11205 and bracket 3832

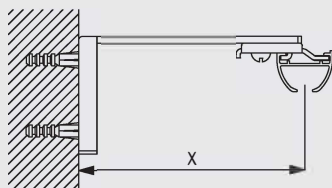

	X (mm)
11200	70
11201	90
11202	110
11203	130
11204	160
11205	210

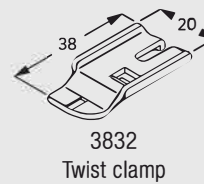
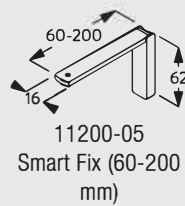

Brackets feature thread for screw SG M4x8

Wall fitting with Square Smart Fix 11210-11215 and bracket 3832

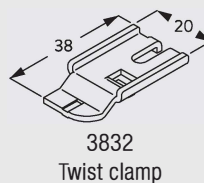
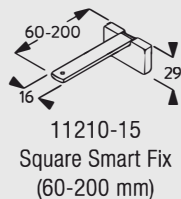
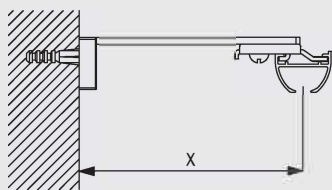

Brackets feature thread for screw SG M4x8

Wall fitting with Universal Smart Fix 11154-11156 and bracket 3832

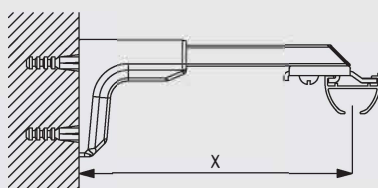

	X (mm)
11154	120-148
11155	150-178
11156	200-228

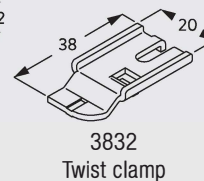
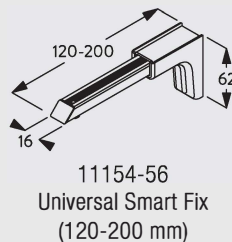

Brackets feature thread for screw SG M4x10

6010

Standard Accessories

3825 Clamp (35mm)



6010 Profile



6018 Endcover



6065 Twist eye endstop



11301 2C glider 11300 on strip (x20)



1148C Countersunk screw

Optional Accessories

3582 Hook



3802 Connecting bridge



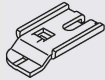

3832 Twist clamp 

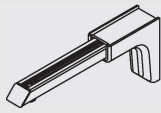
6283 Roller glider 

11155 Universal Smart Fix, 150 mm set 

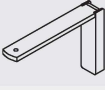
11200 Smart Fix, 60 mm set 

11202 Smart Fix, 100 mm set 

11204 Smart Fix, 150 mm set 

11210 Square Smart Fix, 60 mm set 

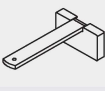
11212 Square Smart Fix, 100 mm set 

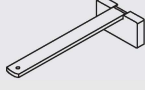
11214 Square Smart Fix, 150 mm set 

6098 Roller glider with eye 

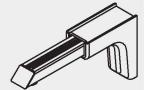
11154 Universal Smart Fix, 120 mm set 

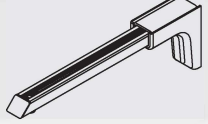
11156 Universal Smart Fix, 200 mm set 

11201 Smart Fix, 80 mm set 

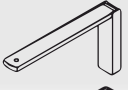
11203 Smart Fix, 120 mm set 

11205 Smart Fix, 200 mm set 

11211 Square Smart Fix, 80 mm set 

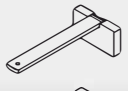
11213 Square Smart Fix, 120 mm set 

11215 Square Smart Fix, 200 mm set 

Wave Accessories

6099 Wave roller glider cord (80mm) 

6363 Top hemming tape 

10076 Fabric weight 

11303 Wave 2C glider cord 60 mm 

6349 Curtain tape 

10075 Lead weight 50 gr/m 

11302 Wave 2C glider cord 80 mm 



6010

Useful Measures

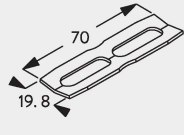
3802 Connecting bridge 

6018 Endcover 